



DECOJARDÍ  
EMPORDÀ



FÁBRICA DE PIEDRA ARTIFICIAL

FABRIQUE EN VIELLE PIERRE

FACTORY OF ARTIFICIAL STONE

# INDICE SOMMAIRE INDEX

4	<b>PRODUCTOS / PRODUITS / PRODUCTS</b>
5	<b>PEDIDOS / COMMANDES / ORDERS</b>
6	<b>NOTAS / NOTES / NOTES</b>
7	<b>BOMBAS / POMPES / PUMPS</b>
8	<b>KIT DE AGUA / KIT D'EAU / WATER KIT</b>
9	<b>KIT DE LUZ / KIT D'ECLAIRAGE / ELECTRICITY KIT</b>
10	<b>ACCESORIOS / ACCESSOIRES / ACCESSORIES</b>
12	<b>ABREVADEROS / AUGES / TROUGHS</b>
16	<b>POZOS / PUIITS / WELLS</b>
17	<b>COPAS / COUPES / GOLBLETS</b>
19	<b>JARDINERAS / JARDINIERES / WINDOW BOXES</b>
23	<b>SALONES / SALONS / LOUNGES</b>
24	<b>PICAS Y BARBACOA / PIQUES ET BARBACOA / GOADS AND BARBECUE</b>
25	<b>BANCOS / BANCS / BENCHES</b>
26	<b>RELOJES / CADRAN SOLAIRE / CLOCKS</b>
28	<b>FUENTES / FONTAINES / FOUNTAINS</b>
36	<b>FUENTES CENTRALES / FONTAINES CENTRALES / CENTRAL FOUNTAINS</b>
39	<b>ANIMALES / ANIMAUX / ANIMAL</b>
44	<b>FIGURAS / STATUES / FIGURES</b>
51	<b>MOLINOS / MOULINS / WINDMILLS</b>
52	<b>PIZARRA / ARDOISE / SLATE</b>
53	<b>COLUMNAS / COLONNES / COLUMNS</b>
54	<b>VARIOS / DIVERS / OTHERS</b>
56	<b>DECO CHINA</b>
57	<b>MOBILIARIO ALUMINIO ABS / MOBILIER ALUMINIUM ABS / ALUMINIUM ABS FURNITURE</b>
60	<b>MOBILIARIO / MOBILIER / FURNITURE</b>
61	<b>HIERRO / FER / IRON</b>
63	<b>PIEDRA NATURAL / PIERRE NATURAL / NATURAL STONE</b>



**DECOJARDÍ**  
EMPORDÀ

# LA EMPRESA L'ENTREPRISE THE COMPANY



DECOJARDI es una empresa ubicada en Agullana (en la frontera entre España y Francia). Contamos con una superficie de 16.000 m<sup>2</sup> y 2.500 m<sup>2</sup> de naves, una producción de 25 toneladas diarias y una red comercial y logística que nos permite trabajar en cualquier parte del mundo.

Nuestra empresa está pendiente de certificación de la ISO 9002 que acredita la calidad en la concepción del diseño, la producción, los acabados y el servicio post-venta.

DECOJARDI est une société sise à Agullana (à la frontière franco-espagnole). Nous disposons d'une superficie de 16 000 m<sup>2</sup> et de 2 500 m<sup>2</sup> de hall, une production de 25 tonnes par jour et un réseau commercial et logistique qui nous permet de travailler dans le monde entier.

Notre société est en attente d'obtenir le certificat ISO 9002 qui accrédite la qualité en ce qui concerne la conception du design, la production, les finitions et le service après-vente.

DECOJARDI is located in Agullana (near the Spanish border with France). With 16,000 m<sup>2</sup> of land and 2,500 m<sup>2</sup> of industrial premises, we have a daily production of 25 tons and a commercial and logistic network that enables us to offer a worldwide service.

Our company is international standard ISO 9002 pending. This standard proves quality in design conception, production, finishes and after-sales service.

# LOS PRODUCTOS LES PRODUITS OUR PRODUCTS



**PIEDRA VIEJA  
PROVENZAL**

VIELLE PIERRE  
PROVENÇALE

OLD STONE  
PROVENÇALE



**PIEDRA VIEJA  
RÚSTICO**

VIELLE PIERRE  
RUSTIQUE

OLD STONE  
RUSTIC

DECOJARDI ofrece dos líneas de productos:

**LINEA PIEDRA VIEJA:** abrevaderos, jardineras, fuentes, pozos, copas, salones... esta gama se caracteriza por la fabricación con arena granulada, es una auténtica imitación de la piedra antigua.

En nuestro catálogo se muestran estas piezas con el fondo de color verde en el apartado donde se ubican las referencias. Se pueden suministrar con dos colores patinados, rústico y provenzal.

**LINEA PIEDRA ARTIFICIAL:** fuentes, figuras, animales, copas... esta gama se caracteriza por la fabricación con arena fina de mármol, estas piezas presentan una definición más perfecta y unos acabados más lisos.

En nuestro catálogo se muestran estas piezas con el fondo de color azul en el apartado donde se ubican las referencias. Esta línea presenta tres colores patinados (rústico, gris y provenzal) y blanco.

DECOJARDI offre deux lignes de produits:

**LIGNE VIELLE PIERRE:** auges, jardinières, fontaines, puits, coupes, salons,... cette gamme se caractérise par la fabrication avec du sable granulé, c'est une authentique imitation de la vielle pierre.

Dans notre catalogue ces pièces sont avec le fond vert dans la zone écrite des références. Elles peuvent se fournir avec deux couleurs de patine, rustique et provençale.

**LIGNE PIERRE ARTIFICIELLE:** fontaines, statues, animaux, coupes..., cette gamme se caractérise par la fabrication avec du sable fin de marbre, ces pièces présentent une définition plus parfaite et des finitions plus lisses.

Dans notre catalogue ces pièces sont avec le fond bleu dans la zone écrite des références. Cette ligne présente trois couleurs patinées (rustique, gris et provençale) et blanc.

DECOJARDI has two lines of product:

**OLD STONE RANGE:** troughs, window boxes, fountains, wells, goblets, lounges and so on. This range is made using granulated sand and is a true imitation of old stone.

In our catalogue the products are shown with a green references background. They can also be supplied in two patina finishes, rustic and provençal.

**ARTIFICIAL STONE RANGE:** fountains, figures, animals, goblets and so on. This range is made using fine marble sand and the pieces are more perfectly defined and have a smoother finish.

In our catalogue the products are shown with a blue references background. Three colours patina (rustic, grey and provençal) and white.



**PIEDRA ARTIFICIAL  
PATINADO PROVENZAL**

PIERRE ARTIFICIEL  
PATINÉE PROVENÇALE

ARTIFICIAL STONE  
PROVENÇAL PATINA



**PIEDRA ARTIFICIAL  
PATINADO GRIS ITALIANO**

PIERRE ARTIFICIEL  
PATINÉE GRIS ITALIEN

ARTIFICIAL STONE  
ITALIAN GREY PATINA



**PIEDRA ARTIFICIAL  
PATINADO BLANCO**

PIERRE ARTIFICIEL  
PATINÉE BLANC

ARTIFICIAL STONE  
WHITE PATINA



**PIEDRA ARTIFICIAL  
PATINADO RÚSTICO**

PIERRE ARTIFICIEL  
PATINÉE RUSTIQUE

ARTIFICIAL STONE  
RUSTIC PATINA

# PEDIDOS COMMANDES ORDERS



## COMO HACER UN PEDIDO

1- Marcar la referencia deseada del catálogo, (ésta ya indica si es de la línea de Piedra Artificial con el fondo de referencias azul, o si es de la línea Piedra Vieja con el fondo de referencias verde).

2- Después de la referencia hay que indicar el patinado deseado siguiendo las indicaciones de la página 5 del catálogo.

## NOTAS

Las medidas presentes en este catálogo están en sistema europeo y en sistema inglés. Su tabla de equivalencias es la siguiente:

**Ref:** Referencia de la pieza, **Kg.:** Peso total de la pieza en kilos, **L:** Largo de la pieza en centímetros, **A:** Ancho de la pieza en centímetros, **H:** Alto de la pieza en centímetros, **G:** Grosor de la pieza en centímetros, **Ø:** Diámetro de la pieza en centímetros, **B:** Base de la pieza en centímetros.

- Generalmente los palets son de 120 x 80 cm.
- En las fuentes hay que especificar claramente el tipo de referencia: circuito cerrado (CR), circuito abierto (Ref. Fuente).
- En los pedidos de más de dos palets va incluido un kit de reparación.

## COMMENT FAIRE UNE COMMANDE

1- Marquer la référence désirée du catalogue, (celle-ci nous indique si elle est de la ligne Pierre Artificielle avec le fond des références en bleu ou si elle est de la ligne Vielle Pierre avec le fond des références en vert).

2- Après la référence il faut nous indiquer la couleur choisie suivant les indications de la page 5 du catalogue.

## NOTES

Les dimensions qu'on retrouve dans ce catalogue sont avec le système européen et le système anglais.

La table d'équivalence des mesures est la suivante.

**Ref:** Référence de la pièce, **Kg.:** Poids total de la pièce en kilos, **L:** Longueur de la pièce en centimètres, **A:** Largeur de la pièce en centimètres, **H:** Hauteur de la pièce en centimètres, **G:** Grosseur de la pièce en centimètres, **Ø:** Diamètre de la pièce en centimètres, **B:** Base de la pièce en centimètres.

- Généralement les palets sont de 120 x 80 cm.
- Dans les fontaines il faut bien préciser le type de référence: circuit fermé (CR), circuit ouvert (Ref. Fontaine).
- Sur les commandes de plus de deux palets, est inclus un kit de réparation.

## HOW TO PLACE AN ORDER

1- Note the reference you require from the catalogue (this will show whether it is from the Artificial Stone Range with the background of the references in blue or whether it is from the Old Stone Range with the background references in green).

2- After the reference number please indicate the colour required following the indications on page 5 of the catalogue.

## NOTAS

The sizes found in this catalogue are given in the European system and the English system.

The table of equivalence for sizes is as follows:

**Ref:** Reference for the piece, **Kg.:** Total weight of the piece in kilos, **L:** Length of the piece in centimetres, **A:** Width of the piece in centimetres, **H:** Height of the piece in centimetres, **G:** Thickness of the piece in centimetres, **Ø:** Diameter of the piece in centimetres, **B:** Base of the piece in centimetres

- The pallets are usually 120 x 80 cm.
- In the case of fountains, please specify clearly the type of circuit and the accessories you require with their corresponding reference numbers.
- In orders of more than two pallets, a repair kit is included.

# NOTAS

## NOTES

## NOTES



- Al ser un producto muy artesanal, nuestras piezas pueden sufrir pequeñas variaciones en sus acabados.
- Los pesos y medidas pueden variar un 10% según el molde o el secado de la pieza.
- La empresa no se hace responsable de las posibles variaciones de color de una pieza a otra por características de la pieza, secado, humedad, tipo de molde,...
- Todos los accesorios eléctricos y de agua se sirven según las normas del país de que procede el pedido.
- Nuestros productos están preparados con una serie de aditivos, para resistir los cambios climatológicos, pero se recomienda vaciar el agua de los cuencos de las fuentes en tiempo de heladas, para evitar que se agrieten.
- Todas las piezas van paletizadas y protegidas con cartón o paja de madera y después embaladas con film de 35 micras. Los palets son de 120x80 cm. Los palets para containers son de 120x80 y 90x90 cm.

- Etant un produit très artisanal, nos pièces peuvent avoir des petites variations dans leur finition.
- Les poids et mesures peuvent varier un 10% suivant le modèle ou le séchage de la pièce.
- L'entreprise ne se fait pas responsable des possible variations de couleur d'une pièce à l'autre pour les caractéristiques de la pièce, séchage, humidité, type de modèle.
- Tous les accessoires électriques et d'eau se servent suivant les normes du pays d'où procède la commande.
- Nos produits sont préparés avec une série d'additifs pour résister aux changements climatologiques, mais il se recommande de vider l'eau des bassins des fontaines en temps de gel, pour éviter qu'ils ne se lézardent pas.
- Toutes les pièces vont palettisées et protégées avec du carton ou paille de bois et emballées avec un film de 35 micras. Les palets sont de 120x80 cm. Les palets pour les containers sont de 120x80 cm et de 90 x90 cm.

- As this is a traditionally made product, our pieces can have slight variations in their finishes.
- The weights and sizes can vary up to 10% depending on the mould or the way in which the piece has dried.
- The company will not be held responsible for any possible variations in colour of a piece or for any other characteristic of the stone, the way in which it has dried, dampness, type of mould, etc.
- All electrical and water accessories are served to comply with the regulations of the country from which the order has been placed.
- Our products are prepared with a series of additives to resist climatic changes, however, it is advisable to empty the water from the bowls in the fountains if frosty to prevent them from cracking.
- All the pieces are packed in pallets and protected with cardboard of wood chips and later wrapped in film with 35 micras. Pallets are 120x80 cm. Pallets for containers are 120x80 and 90x90 cm.



# BOMBAS POMPES PUMPS



Las bombas proporcionan una gran versatilidad de aplicaciones y, gracias a su moderno diseño, ofrecen unas excelentes calidades de potencia.

Las bombas más potentes incorporan la nueva tecnología unidireccional.

Disponibles con flujos comprendidos entre 420 y 5.000 l/h.

Les pompes présentent une grande versatilité quant aux applications, et grâce à la modernité de leur design, elles offrent d'excellentes performances quant à la puissance.

Les plus puissantes disposent de la nouvelle technologie unidirectionnelle.

Disponibles avec des débits compris entre 420 et 5 000 l/h.

The pumps are extremely versatile in their applications and link to the modern design great power qualities.

The most powerful pumps are with the new unidirectional technology.

Available with flow ranging from 420 to 5.000 l/h.



#### Ref. BOMBAS

400 L	AC 9	
800 L	AC 10	
2.300 L	AC 11	
4.000 L	AC 12	

Normas UE  
Normes UE  
UE Norms

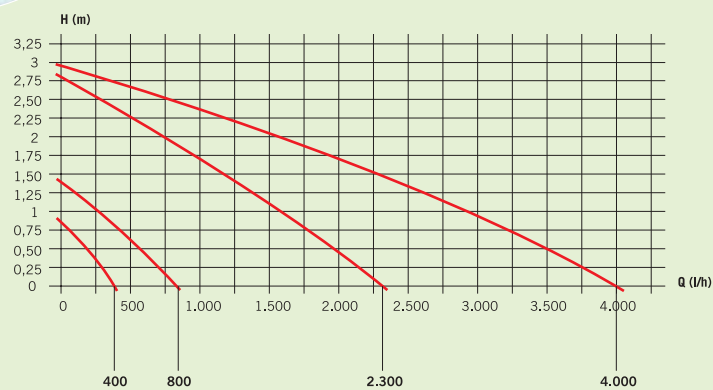

		400	800	2.300	4.000
Potencia / Puissance / Power	W	6	13,5	53	73
Caudal max / Volume max Max flow	lt/h	420	650	2.200	3.700
	USG/h	111	172	581	978
Prevalencia / Prevalence Max head	m	0,85	1,3	2,85	2,80
	ft	2,8	4,2	9,4	9,2

# KIT DE AGUA KIT D'EAU WATER KIT

## Ref. KIT DE AGUA D

Ref. KIT DE AGUA D / KIT D'EAU D / WATER KIT D  
Para fuente / Pour fontaine / For fountain – F19 EXTRA, F31 EXTRA

BOMBA AC20 + 1 aro de cobre de 150 cm. de diámetro con tubo de 18 mm. + 8 chorros de 2,5 mm. + 210 cm. de tubo de 10/14 + 2 llaves de paso + 1 prensa de estopa + AC3.

POMPE AC20 + 1 anneau en cuivre de 150 cm. de diamètre avec tube de 18 mm. + 8 jets de 2,5 mm. + 210 cm. de tube de 10/14 + 2 robinets + 1 pompe à eau + AC3.

PUMP AC20 + 1 copper ring of 150 cm. diameter with 18 mm. tubing + 8x2,5 mm. jets + 210 cm of 10/14 tubing + 2 stopcocks + 1 pressure filter + AC3.

## Ref. KIT DE AGUA E

Ref. KIT DE AGUA E / KIT D'EAU E / WATER KIT E

BOMBA AC20 + 2 aros de cobre de 150 cm. de diámetro con tubo de 18 mm. + 12 chorros de 2,5 mm. + 210 cm. de tubo de 10/14 + 3 llaves de paso + 1 prensa de estopa + AC3.

POMPE AC20 + 2 anneaux en cuivre de 150 cm. de diamètre avec tube de 18 mm. + 12 jets de 2,5 mm. + 210 cm. de tube de 10/14 + 3 robinets + 1 pompe à eau + AC3.

PUMP AC20 + 2 coppers rings of 150 cm. diameter with 18 mm. tubing + 12x2,5 mm. jets + 210 cm. of 10/14 tubing + 3 stopcocks + 1 pressure filter + AC3.

## Ref. KIT DE AGUA F

Ref. KIT DE AGUA F / KIT D'EAU F / WATER KIT F  
Para fuente / Pour fontaine / For fountain – F21 EXTRA

BOMBA AC21 + 1 aro de cobre de 300 cm. de diámetro con tubo de 35 mm. + 34 chorros de 4 mm. + 10 mts. de tubo de 10/14 + 3 llaves de paso + 120 cm. de tubo de 50 mm. de diámetro flexible + 2 enlaces de 50 mm. 1 prensa de estopa + AC19.

POMPE AC21 + 1 anneau en cuivre de 300 cm. de diamètre avec tube de 35 mm. + 34 jets de 4 mm. + 10 mts. de tube de 10/14 + 3 robinets + 120 cm. de tube de 50 mm. de diamètre flexible + 2 manchons de branchement de 50 mm. + 1 pompe à eau + AC19.

PUMP AC21 + 1 copper ring of 300 cm. diameter with 35 mm. tubing + 34x4 mm. jets + 10 m. of 10/14 tubing + 3 stopcocks + 120 cm. of 50 mm. diameter flexible tubing + 2x50 mm. joins + 1 pressure filter + AC19.



# KIT DE LUZ KIT D'ECLEIRAGE ELECTRICITY KIT



Ref. KIT DE LUZ G

Ref. KIT DE LUZ G / KIT D'ECLEIRAGE G / ELECTRICITY KIT G  
Para fuente / Pour fontaine / For fountain – F19 SPE, F14 SPE, F30 SPE, F31 SPE

4 focos + 1 kit de cristales de diferentes colores + 4 transformadores + 40 mts. de cable + 4 prensas de estopa + 1 cuadro de conexión térmico + 5 diferenciales + 1 térmico.

4 projecteurs + 1 kit de verres de diferentes couleurs + 4 transformateurs + 40 mts. de fil électrique + 4 pompes à eau + 1 tableau de branchement thermique + 5 compteurs + 1 thermique.

4 lamps + a kit crystals of different colors + 4 transforming + 40 m. cable + 4 pressure filter + 1 thermal panel of connection + 5 differentials + 1 thermal.

Ref. KIT DE LUZ H

Ref. KIT DE LUZ H / KIT D'ECLEIRAGE H / ELECTRICITY KIT H  
Para fuente / Pour fontaine / For fountain – F21 SPE

12 focos + 1 kit de cristales de diferentes colores + 12 transformadores + 100 mts. de cable + 12 prensas de estopa + 1 cuadro de conexión térmico + 13 diferenciales + 1 térmico.

12 projecteurs + 1 kit de verres de diferentes couleurs + 12 transformateurs + 100 mts. de fil électrique + 12 pompes à eau + 1 tableau de branchement thermique + 13 compteurs + 1 thermique.

12 lamps + a kit crystals of different colors + 12 transforming + 100 m. cable + 12 pressure filter + 1 thermal panel of connection + 13 differentials + 1 thermal.

## REPARACIÓN / REPARATION / REPAIR

Ref. PT1

KIT DE PATINADO / KIT CRÉPI / PATINA KIT  
Bolsa con patin rústico / Sac de crépi rustique / Bag with rustic patina

Ref. PT2

KIT DE PATINADO / KIT CRÉPI / PATINA KIT  
Bolsa con patin ocre / Sac de crépi ocre / Bag with ocre patina

Ref. PT3

KIT DE REPARACIÓN / KIT RÉPARATION / REPAIR KIT  
Bolsa con arena de mármol /  
Sac de poudre de marbre et ciment blanc / Bag with marble sand and white cement.

# ACCESORIOS ACCESSOIRES ACCESSORIES

Ref. AC7

Kg 5

A 52 cm

H 101 cm

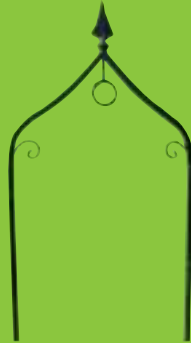

Ref. AC8

Kg 7

A 59 cm

H 148 cm

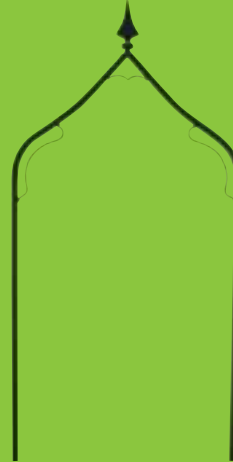

Ref. AC22

Kg 12

A 90 cm

H 120 cm

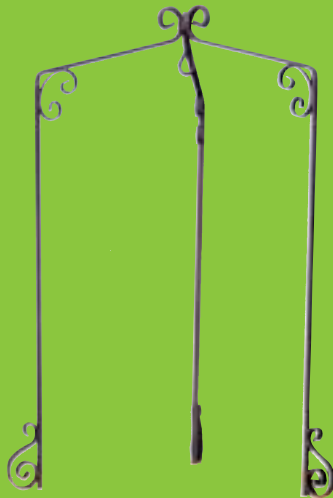

Ref. AC2

Kg 1

Ø 19 cm



Ref. AC3

Kg 30

H 22 cm

Ø 150 cm



Ref. AC18

Kit de chorros para  
fuentes y laguitos.

Kit de buses pour pompes  
fontaine et bassin.

Nozzles kit for fountains  
and ponds.

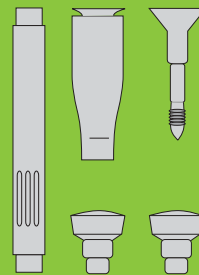

# ACCESORIOS ACCESSOIRES ACCESSORIES

Ref. AC13

L 29 cm



Ref. AC14

L 34 cm

Ref. AC4



Ref. AC17

Kg 0,25

Ø 28 cm

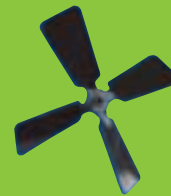

Ref. HAN6



Ref. AC5

Kg 0,5

Ø 48 cm



Ref. AC6

Kg 0,75

Ø 68 cm



Ref. HF2145

Ref. HF2245

Ref. HF26

Ref. HF53

Ref. HF54

Ref. AC16

Bola luz E55



# ABREVADEROS AUGES TROUGHS

Ref. A1
Kg 27
L 58 cm
A 36 cm
H 20 cm



Ref. A2
Kg 11
L 40 cm
A 23 cm
H 14 cm



Ref. A3
Kg 13
L 37 cm
A 29 cm
H 16 cm



Ref. A4
Kg 30
L 48 cm
A 37 cm
H 21 cm



Ref. A5
Kg 12
H 30 cm
Ø 22 cm



Ref. A7
Kg 38
L 72 cm
A 39 cm
H 19 cm



Ref. A8
Kg 64
H 25 cm
Ø 60 cm



Ref. A9
Kg 14
H 20 cm
Ø 30 cm



# ABREVADEROS AUGES TROUGHS

## Ref. A10

Kg	48
L	60 cm
A	38 cm
H	28 cm



## Ref. A11

Kg	76
L	98 cm
A	40 cm
H	30 cm



## Ref. A12

Kg	40
H	32 cm
Ø	51 cm



## Ref. A13

Kg	33
L	69 cm
A	36 cm
H	22 cm



## Ref. A14

Kg	60
L	70 cm
A	39 cm
H	27 cm



## Ref. A15

Kg	220
L	122 cm
A	51 cm
H	39 cm



## Ref. PIE2

Kg	15
L	50 cm
A	10 cm
H	15 cm

# ABREVADEROS AUGES TROUGHS

Ref. A17

Kg 25  
L 66 cm  
A 23 cm  
H 19 cm



Ref. A18

Kg 41  
L 78 cm  
A 24 cm  
H 20 cm



Ref. A19

Kg 75  
L 85 cm  
A 44 cm  
H 30 cm



Ref. PIE1

Kg 5  
L 42 cm  
A 8 cm  
H 8 cm



Ref. A20

Kg 100  
L 99 cm  
A 40 cm  
H 28 cm



Ref. A16

Kg 41  
L 67 cm  
A 37 cm  
H 19 cm



# ABREVADEROS AUGES TROUGHS

Ref. A21

Kg 162  
L 124 cm  
A 49 cm  
H 34 cm



Ref. A22

Kg 138  
L 79 cm  
A 63 cm  
H 32 cm



Ref. A23

Kg 69  
L 56 cm  
A 44 cm  
H 24 cm



Ref. A17N

Kg 26  
L 64 cm  
A 22 cm  
H 18 cm



Ref. A24

Kg 72  
L 48 cm  
A 61 cm  
H 78 cm



Ref. AC23

Kg 8  
L 25 cm  
A 40 cm

(BOMBA MANUAL)

Ref. AC24

Kg 67  
L 39 cm  
A 26 cm

(ABREVADERO)

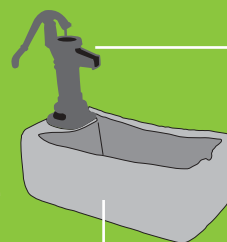



# POZOS PUITS WELLS

(Pozo+AC7)

Ref. P1

Kg 158  
H 63 cm  
Ø 62 cm



(Pozo+AC7)

Ref. P4

Kg 139  
H 61 cm  
Ø 62 cm

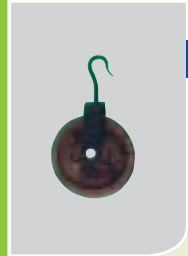

Ref. AC2

OPCIONAL

(Pozo+AC8)

Ref. P2

Kg 229  
H 71 cm  
Ø 78 cm



(Pozo+AC22)

Ref. P5

Kg 400  
Ø 95 cm  
H 209 cm



Ref. P2C

Kg 56  
H 15 cm  
Ø 69 cm

Ref. P2B

Kg 84  
H 41 cm  
Ø 60 cm

Ref. P2A

Kg 89  
H 15 cm  
Ø 78 cm

AC22

P5A (1 pieza)

P5B (1 pieza)

P5C (5 piezas)

P5D (2 piezas)

# COPAS COUPES GOBLETES

Ref. C1

Kg 44  
H 50 cm  
Ø 43 cm



Ref. C2

Kg 49  
H 53 cm  
Ø 43 cm



Ref. C4

Kg 35  
L 42 cm  
A 42 cm  
H 33 cm



Ref. C9

Kg 48  
H 59 cm  
Ø 49 cm



Ref. C5

Kg 80  
H 75 cm  
Ø 49 cm



Ref. C6

Kg 29  
H 43 cm  
Ø 39 cm



Ref. C7

Kg 40  
H 55 cm  
Ø 41 cm



Ref. C8

Kg 47  
H 43 cm  
Ø 56 cm



# COPAS COUPES GOBLETS

Ref. C15N
Kg 220
H 56 cm
Ø 100 cm



Ref. C14N
Kg 49
H 33 cm
Ø 59 cm



Ref. C11
Kg 98
H 66 cm
Ø 81 cm

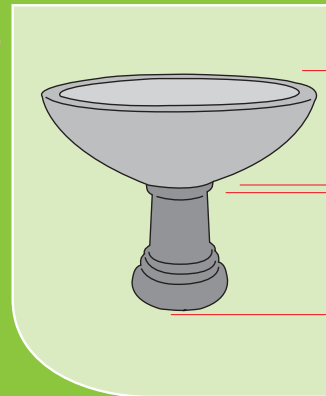

Ref. C11B
Kg 64
H 27 cm
Ø 81 cm

Ref. C11A
Kg 34
H 39 cm
Ø 33 cm

Ref. C18
Kg 81
H 64 cm
Ø 67 cm

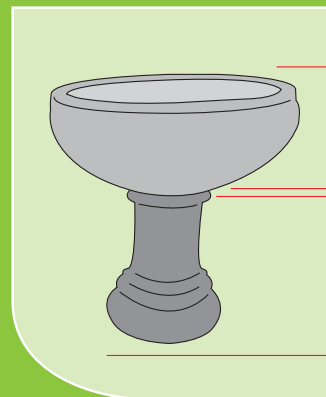

Ref. C18A
Kg 47
H 25 cm
Ø 67 cm

Ref. C11A
Kg 34
H 39 cm
Ø 33 cm

Las referencias C19 y C11 estan preparadas para hacer la función de fuente central con un prensa de estopas.

Les références C19 et C11 peuvent être utilisées comme fontaine centrale avec une presse d'eau.

Models C19 and C11 can function as central fountains when used with a pressure filter.



# JARDINERAS JARDINIERES WINDOW BOXES

Ref. J12

Kg	453
L	120 cm
A	82 cm
H	60 cm



Ref. J7

Kg	54
L	81 cm
A	29 cm
H	34 cm



Ref. J8

Kg	127
L	100 cm
A	40 cm
H	41 cm

Ref. J4

Kg	43
H	40 cm
Ø	44 cm



Ref. J2

Kg	58
L	46 cm
A	45 cm
H	47 cm

Ref. J3

Kg	11
H	29 cm
Ø	34 cm



Ref. J1

Kg	62
L	70 cm
A	35 cm
H	31 cm

# JARDINERAS JARDINIERES WINDOW BOXES

Ref. J22

Kg 29  
L 37 cm  
A 37 cm  
H 36 cm



Ref. J23

Kg 11  
H 29 cm  
Ø 34 cm



Ref. J24

Kg 17  
L 49 cm  
A 32 cm  
H 22 cm



Ref. J27

Kg 17  
L 49 cm  
A 32 cm  
H 22 cm

Ref. J26

Kg 11  
H 29 cm  
Ø 34 cm



Ref. J25

Kg 29  
L 37 cm  
A 37 cm  
H 36 cm

Ref. J10

Kg 20  
L 31 cm  
A 42 cm



Ref. J11

Kg 36  
L 52 cm  
A 50 cm





# JARDINERAS JARDINIERES WINDOW BOXES

Ref. J35

Kg 12  
Ø 30 cm  
H 20 cm



Ref. J39

Kg 12  
Ø 30 cm  
H 23 cm

Ref. J36

Kg 15  
L 31 cm  
A 31 cm  
H 23,3 cm



Ref. J40

Kg 15  
L 31 cm  
A 31 cm  
H 23,3 cm

Ref. J37

Kg 10  
L 38 cm  
A 20 cm  
H 17 cm



Ref. J41

Kg 10  
L 38 cm  
A 20 cm  
H 17 cm

Ref. J38

Kg 9  
L 38 cm  
A 20 cm  
H 17 cm



Ref. J42

Kg 9  
L 38 cm  
A 20 cm  
H 17 cm

Ref. J53

Kg 14,01  
L 30 cm  
A 30 cm  
H 22 cm



Ref. J54

Kg 9  
L 39 cm  
A 21 cm  
H 22 cm

# JARDINERAS

## JARDINIERES

## WINDOW BOXES

Ref. J43

**Kg** 12  
**Ø** 30 cm  
**H** 20 cm



Ref. J47

**Kg** 12  
**Ø** 30 cm  
**H** 20 cm

Ref. J44

**Kg** 15  
**L** 31 cm  
**A** 31 cm  
**H** 23,5 cm



Ref. J48

**Kg** 15  
**L** 31 cm  
**A** 31 cm  
**H** 23,5 cm

Ref. J45

**Kg** 10  
**L** 38 cm  
**A** 20 cm  
**H** 17 cm



Ref. J49

**Kg** 10  
**L** 38 cm  
**A** 20 cm  
**H** 17 cm

Ref. J46

**Kg** 9  
**L** 38 cm  
**A** 20 cm  
**H** 17 cm



Ref. J50

**Kg** 9  
**L** 38 cm  
**A** 20 cm  
**H** 17 cm

Ref. J51

**Kg** 9,94  
**Ø** 30 cm  
**H** 21 cm



Ref. J52

**Kg** 11,3  
**Ø** 28 cm  
**H** 25 cm



# SALONES SALONS LOUNGES

Ref. S3

(S3M + S3PM1 + S3PM2 + (2) S3B + (4) S3PB)

Kg 428



Ref. S3PM2

Kg 33  
H 38 cm  
Ø 37 cm

Ref. S3PM1

Kg 41  
L 44 cm  
A 42 cm  
H 33 cm

Ref. S3M

Kg 88  
G 7 cm  
Ø 110 cm

Ref. S3B

Kg 65  
L 150 cm  
A 42 cm  
G 7 cm

Ref. S3PB

Kg 34  
L 44 cm  
A 18 cm  
H 38 cm

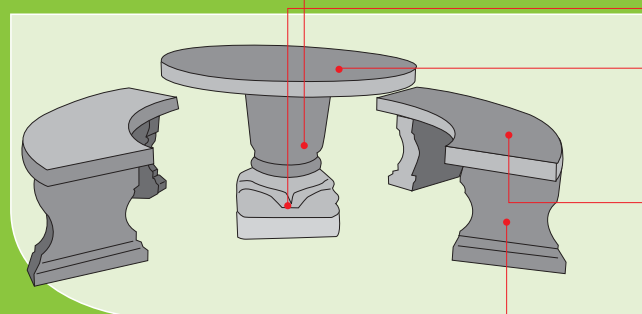

Ref. S1C

(S1M + S1PM + (2) S1B + (4) S1PB)

Kg 575



Ref. S1M

Kg 198  
G 9 cm  
Ø 118 cm

Ref. S1B

Kg 77  
L 147 cm  
A 33 cm  
G 9 cm

Ref. S1PB

Kg 27  
A 40 cm  
Ø 28 cm

Ref. S1PM

Kg 115  
H 62 cm  
Ø 52 cm

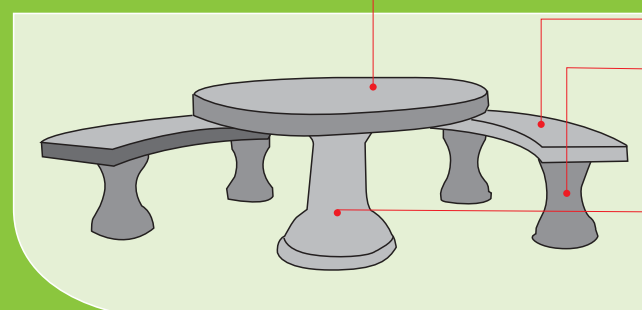

# PICAS Y BARBACOA PIQUES ET BARBACOA GOADS AND BARBECUE

Ref. PIC 1

**Kg** 188  
**L** 89 cm  
**A** 53 cm  
**H** 86 cm



Ref. PIC1A

**Kg** 92  
**L** 89 cm  
**A** 53 cm  
**H** 15 cm

Ref. PIC1B

**Kg** 48  
**L** 30 cm  
**A** 10 cm  
**H** 71 cm

Ref. PIC2

**Kg** 177  
**L** 90cm  
**A** 54 cm  
**H** 87 cm



Ref. PIC2A

**Kg** 77  
**L** 90cm  
**A** 54 cm

Ref. PIC2B

**Kg** 50  
**A** 30 cm  
**H** 75 cm

06-07  
novedades  
nouveautés  
news

Ref. AC24 (Grill)

Ref. B2E

Ref. B2D

Ref. B2C

Ref. B2B

Ref. B2A

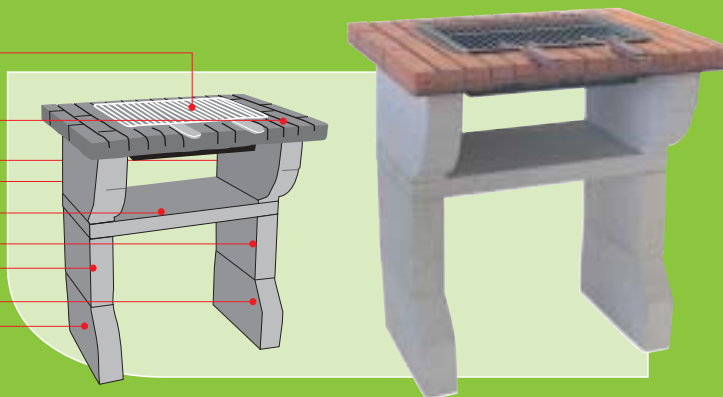

Ref. B2

**Kg** 150  
**L** 78 cm  
**A** 56 cm  
**H** 85 cm

Ref. B1

**Kg** 250  
**L** 100 cm  
**A** 56 cm  
**H** 105 cm

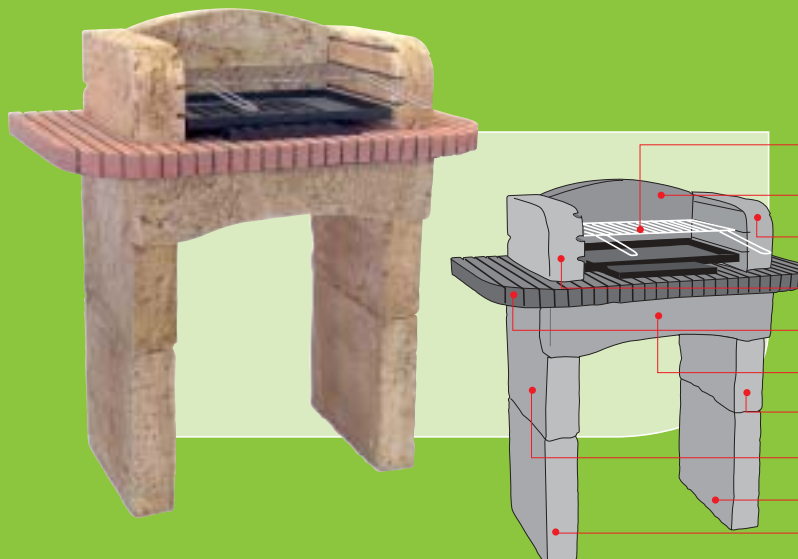

Ref. AC25 (Grill)

Ref. B1F

Ref. B1E-D

Ref. B1E-IZQ

Ref. B1D

Ref. B1C

Ref. B1B-D

Ref. B1B-IZQ

Ref. B1A

# BANCOS BANCS BENCHS

(S5B+(2) S5P)

Ref. S5

Kg 206  
L 150cm  
A 31 cm  
H 69 cm

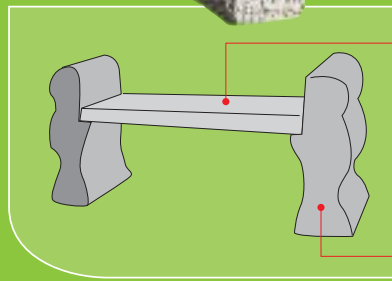

Ref. S5B

Kg 48  
L 109 cm  
A 31 cm  
G 7 cm

Ref. S5P

Kg 79  
L 25 cm  
A 31 cm  
H 69 cm

(S6B+(2) S6P)

Ref. S6

Kg 151  
L 120 cm  
A 39 cm  
H 48 cm

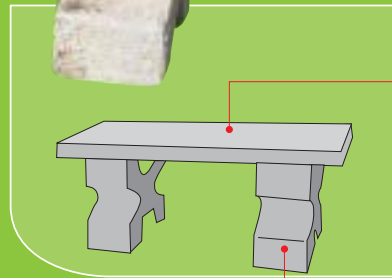

Ref. S6B

Kg 65  
L 120 cm  
A 39 cm  
G 7 cm

Ref. S6P

Kg 43  
L 21 cm  
A 35 cm  
H 40 cm

Ref. -S11

Kg 89  
L 105 cm  
A 34 cm  
H 51 cm

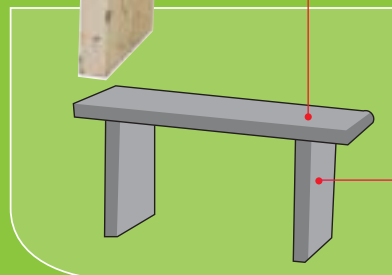

Ref. S11B

Kg 47  
L 105cm  
A 34 cm

Ref S11P

Kg 21  
L 34 cm  
A 6,5 cm  
H 45 cm

06-07  
novedades  
nouveau  
news

# RELOJES CADRAN SOLAIRE CLOCKS

(RELOJ+AC14) **Ref. CAD1**  
**Kg** 6,03  
**A** 32,5 cm  
**H** 32,5 cm  
**G** 3 cm

**Ref. AC14**



**Ref. AC13**



(RELOJ+AC14) **Ref. CAD3**  
**Kg** 11,5  
**A** 39 cm  
**H** 50 cm  
**G** 3,5 cm

(RELOJ+AC14) **Ref. CAD5**  
**Kg** 9,35  
**A** 32 cm  
**H** 45 cm  
**G** 4 cm

**Ref. R8**  
**Kg** 9  
**G** 3 cm  
**Ø** 41 cm



**Ref. CAD2** (RELOJ+AC14)  
**Kg** 8,33  
**A** 37,5 cm  
**H** 45 cm  
**G** 3 cm

**Ref. ZENIT** (ReLoj+AC13)  
**Kg** 5,5  
**L** 3 cm  
**A** 33 cm  
**H** 42 cm

**Ref. CAD6** (RELOJ+AC14)  
**Kg** 6,18  
**A** 32 cm  
**H** 43 cm  
**G** 3 cm

**Ref. CAD4** (RELOJ+AC13)  
**Kg** 4,43  
**A** 40 cm  
**H** 28 cm  
**G** 3 cm

# RELOJES CADRAN SOLAIRE CLOCKS

(Reloj+AC14) Ref. CARPE DIEM

Kg	22,50
L	6 cm
A	61cm
H	60 cm



(Reloj+AC14) Ref. PEGASO

Kg	23
L	6 cm
A	73 cm
H	58 cm



Ref. AC14



Ref. R15

Kg	13
E	4 cm
A	34 cm
H	53,5 cm



06-07  
novedades  
nouveautes  
news

Ref. R13

Kg	8
E	2 cm
A	32 cm
H	46 cm



06-07  
novedades  
nouveautes  
news

Ref. R14

Kg	6,5
E	3,5 cm
A	27,5 cm
H	36 cm



06-07  
novedades  
nouveautes  
news

\*Bolsa de burbujas incluido en el precio.



# FUENTES FONTAINES FOUNTAINS

Se entregan de dos maneras diferentes:

1- Circuito abierto. Se sirven con tubería y rosca de cobre para poder enroscar un grifo por delante y el agua corriente por detrás. El precio incluye el grifo, la tubería y los hierros de la pica, si los lleva. **Ejemplo: F5**

2- Circuito cerrado. Se sirven con tubería de cobre con roscas a ambas salidas para enroscar el grifo y la bomba, tubería y prensa de estopas para pasar el cable de la bomba. A la hora de hacer el pedido se tiene que especificar el circuito cerrado (CR). El precio incluye la bomba, el grifo y la instalación. **Ejemplo: F5 CR**

Elles sont livrées selon deux systèmes différents :

1- Circuit ouvert. Elles sont vendues avec un tuyau et une partie filetée en cuivre permettant de visser un robinet devant et l'eau courante derrière. Le prix comprend le robinet et les parties métalliques de la vasque, suivant le modèle. **Exemple: F5**

2- Circuit fermé. Vendues avec un tuyau en cuivre et des pièces filetées des deux côtés pour visser le robinet et la pompe, le tuyau et la presse à eau et pouvoir ainsi passer le fil de la pompe. Lors de la commande, vous devez spécifier que vous souhaitez un circuit fermé (CR). La pompe, le robinet et l'installation sont compris dans le prix. **Exemple : F5 CR**

Two different options available:

1- Open circuit: Supplied with copper thread and pipe to enable the connection of a tap to the front part and water supply to the rear part. Tap, pipe, and the metallic parts of the basin (if applicable) are included in the price. **Example: F5**

2- Closed circuit: Supplied with copper pipe with threads in both ends to enable the screwing of the tap and the pump, pipe and pressure filter to pass the pump cable trough. The closed circuit (CR) reference must be specified when making an order. Pump, tap and installation are included in the price. **Example: F5 CR**

(Fuente+AC4) ▲ ▼

Ref. F5
Kg 30
L 31 cm
A 48 cm
H 69 cm
Ref. F5CR

AC9



(Fuente+AC4) ▲ ▼

Ref. F6
Kg 101
L 43 cm
A 48 cm
H 112 cm
Ref. F6CR

AC10



# FUENTES FONTAINES FOUNTAINS

Ref. F50  
Kg 68,5  
L 44 cm  
A 41 cm  
H 76 cm  
Ref. F50CR  
AC10



Ref. F51  
Kg 68,5  
L 44 cm  
A 41 cm  
H 76 cm  
Ref. F51CR  
AC10

Ref. F9  
Kg 200  
L 65 cm  
A 76 cm  
H 120 cm  
Ref. F9CR  
AC10



Ref. F9A  
Kg 58  
A 73 cm  
H 88 cm  
G 6 cm

Ref. A22  
Kg 142  
L 65 cm  
A 76 cm  
H 32 cm

Ref. F13  
Kg 352  
L 73 cm  
A 110 cm  
H 130 cm  
Ref. F13CR  
AC11



Ref. F13B  
Kg 134  
A 95 cm  
H 100 cm  
G 16 cm

Ref. F13A  
Kg 218  
L 73 cm  
A 110 cm  
H 30 cm

\*Embalaje individual de madera incluido en el precio.



# FUENTES FONTAINES FOUNTAINS

Ref. F24  
Kg 132  
L 50 cm  
A 50 cm  
H 94 cm  
Ref. F24CR

(Fuente+AC4)

AC10



Ref. F25

Kg 65  
L 47cm  
A 42cm  
H 78cm

(Fuente+AC4)

Ref. F25CR

AC10

Ref. F8  
Kg 103  
L 50 cm  
A 50 cm  
H 93 cm  
Ref. F8CR

(Fuente+AC4)

AC10



Ref. F10

Kg 137  
L 46 cm  
A 50 cm  
H 108 cm

(Fuente+AC4)

Ref. F10CR

AC10

Ref. F26  
Kg 56  
L 40 cm  
A 35 cm  
H 96 cm  
Ref. F26CR

(Fuente+AC4+HF26)

AC9

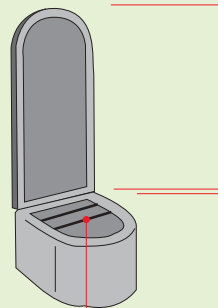

Ref. F26B

Kg 19  
A 35 cm  
H 72 cm  
G 5 cm

Ref. F26A

Kg 37  
L 40 cm  
A 35 cm  
H 24 cm

Ref. HF26

# FUENTES FONTAINES FOUNTAINS

(Fuente+AC4)

Ref. F2247

Kg 31

L 32 cm

A 38 cm

H 77 cm

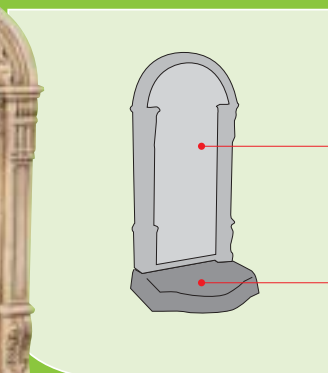

Ref. F2247A

Ref. F2247B

Ref. F53

Kg 60

L 47 cm

A 42 cm

H 78 cm

(Fuente+AC4+HF53)

Ref. F53CR

AC9

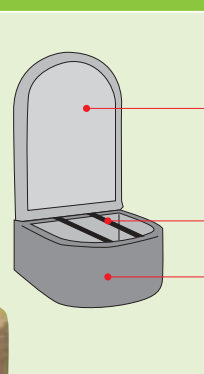

Ref. F53A

Ref. HF53

Ref. F53B

Ref. F54

Kg 30

L 35 cm

A 34 cm

H 69 cm

(Fuente+AC4+HF54)

Ref. F54CR

AC9

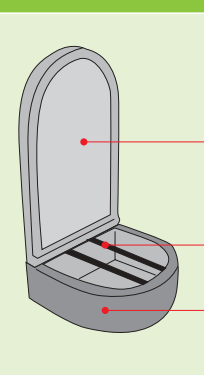

Ref. F54A

Ref. HF54

Ref. F54B

\*Grifo incluido en el precio.

\*Embalaje individual de madera incluido en el precio.

# FUENTES FONTAINES FOUNTAINS

Ref. F2145

Kg 98

L 46 cm

A 62 cm

H 100 cm

Ref. F2145CR

AC10

(Fuente+AC4+HF2145)

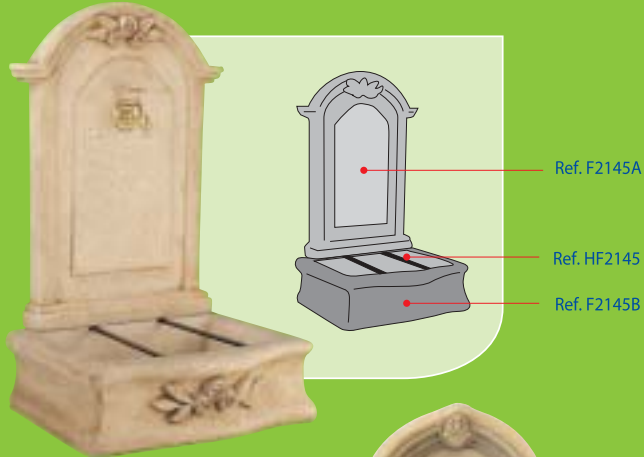

Ref. F2251A

Ref. F2251B



(FUENTE+AC4)

Ref. F2251

Kg 38,5

L 59 cm

H 85 cm

Ref. F2245

Kg 49

L 32 cm

A 46 cm

H 88 cm

(Fuente+AC4+HF2245)

\*Grifo incluido en el precio.

\*Embalaje individual de madera incluido en el precio.



Ref. F7A

Kg 48

A 53 cm

H 72 cm

G 6 cm

Ref. A23

Kg 69

L 44 cm

A 55 cm

H 26 cm

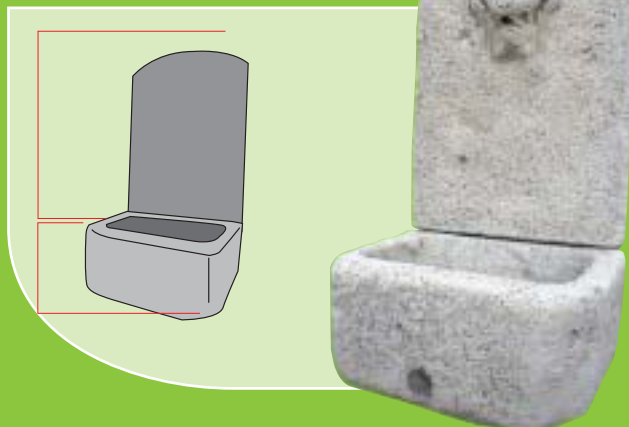

Ref. F7

Kg 117

L 44 cm

A 55 cm

H 98 cm

Ref. F7CR

AC10

# FUENTES FONTAINES FOUNTAINS

Ref. F55A

Ref. F55B

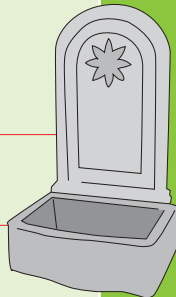

Ref. F55

**Kg** 83  
**L** 42 cm  
**A** 55 cm  
**H** 95 cm



Ref. F56A

Ref. F56B

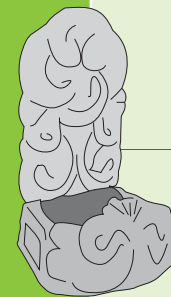

Ref. F56

**Kg** 73  
**L** 44 cm  
**A** 50 cm  
**H** 85 cm



\* El entronque se entrega con el grifo sin estar montado en la fuente.  
\* Le manchon se livre avec le robinet, mais sans monter dans la fontaine.

(FUENTE+AC4+HF2246)

Ref. F2246

**Kg** 90  
**L** 45 cm  
**H** 118 cm

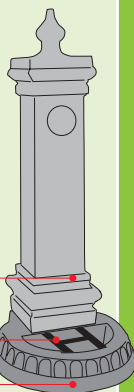

Ref. F2246A

Ref. HF2246A

Ref. F2246B



Ref. F57

**Kg** 41  
**L** 39 cm  
**A** 36 cm  
**H** 78 cm



# FUENTES FONTAINES FOUNTAINS

Ref. F61

**Kg** 28  
**L** 31 cm  
**A** 48 cm  
**H** 59 cm

06-07  
 novedades  
 nouveautes  
 news



Ref. F62

**Kg** 46  
**L** 35 cm  
**A** 34 cm  
**H** 96 cm

06-07  
 novedades  
 nouveautes  
 news



Ref. F63

**Kg** 98  
**L** 62 cm  
**A** 46 cm  
**H** 100 cm

06-07  
 novedades  
 nouveautes  
 news



# FUENTES FONTAINES FOUNTAINS

Ref. F60

**Kg** 267  
**L** 80 cm  
**A** 50 cm  
**H** 114 cm

06-07  
 novedades  
 nouveautes  
 news



Ref. F59

**Kg** 41  
**L** 38 cm  
**A** 36 cm  
**H** 78 cm

06-07  
 novedades  
 nouveautes  
 news



Ref. F58

**Kg** 41  
**L** 39 cm  
**A** 36 cm  
**H** 78 cm

06-07  
 novedades  
 nouveautes  
 news





# FUENTES CENTRALES

## FONTAINES CENTALES

### CENTRAL FOUNTAINS

Las fuentes centrales se sirven con tubería y rosca de cobre para pasar los cables de la bomba y la tubería del agua. Van preparadas con prensa de estopas para la bomba. Algunos modelos se suministran con kit de agua y de luz. La referencia (CR) incluye en el precio la bomba y toda su instalación.

Les fontaines centrales sont vendues avec un tuyau et une vis en cuivre pour pouvoir passer les fils de la pompe et le tuyau d'eau. Elles sont équipées de presse à eau pour la pompe. Certains modèles sont livrés avec un kit d'eau et de lumière. Quant au prix, la référence (CR) comprend la pompe et toute l'installation.

Central fountains are supplied with copper thread and pipe to thread the pump cables and the water pipe. These fountains incorporate with pressure filter for the pump. Some models are supplied with water and lighting kit. Pump and the complete installation are included in the price of the model (CR).

(Fuente+AC9) Ref. F2CR

Kg 160  
H 131 cm  
Ø 78 cm

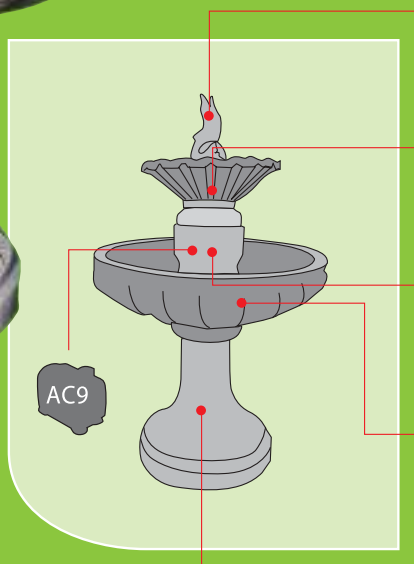

Ref. D3

Kg 5  
H 35 cm  
Ø 13 cm

Ref. F2D

Kg 15  
H 17 cm  
Ø 45 cm

Ref. F2C

Kg 19  
H 30 cm  
Ø 26 cm

Ref. F2B

Kg 49  
L 20 cm  
A 78 cm

Ref. F2A

Kg 72  
H 57 cm  
Ø 47 cm



# FUENTES CENTRALES FONTAINES CENTALES CENTRAL FOUNTAINS

En la referencia F31 hay que especificar en el pedido la referencia según la ubicación de la bomba, en la parte superior (-S) o en la parte inferior (-I). El precio incluye la bomba y su instalación.

Pour le références F31, il faudra spécifier sur la feuille de commande la référence en fonction de la position de la pompe; soit dans la partie supérieure (-S), soit dans la partie inférieure (-I). La pompe et l'installation sont comprises dans le prix.

Orders of the F31 model should include a reference to specify the position of the pump: upper (-S) or lower (-I). Pump and installation are included in the price.

AC11

Ref. F31CR-S
Kg 257
H 182 cm
Ø 116 cm
Ref. F31CR-I

AC11

Ref. F31CR Plus
Kg 665
H 182 cm
Ø 182 cm

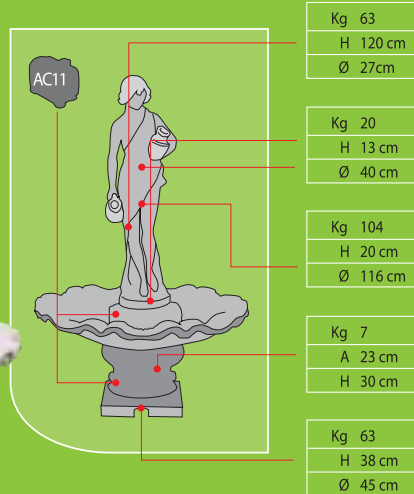
Kg 63
H 120 cm
Ø 27cm
Ref. E14
Kg 20
H 13 cm
Ø 40 cm
Ref. F14D
Kg 104
H 20 cm
Ø 116 cm
Ref. F14C
Kg 7
A 23 cm
H 30 cm
Ref. F14B
Kg 63
H 38 cm
Ø 45 cm
Ref. F14A

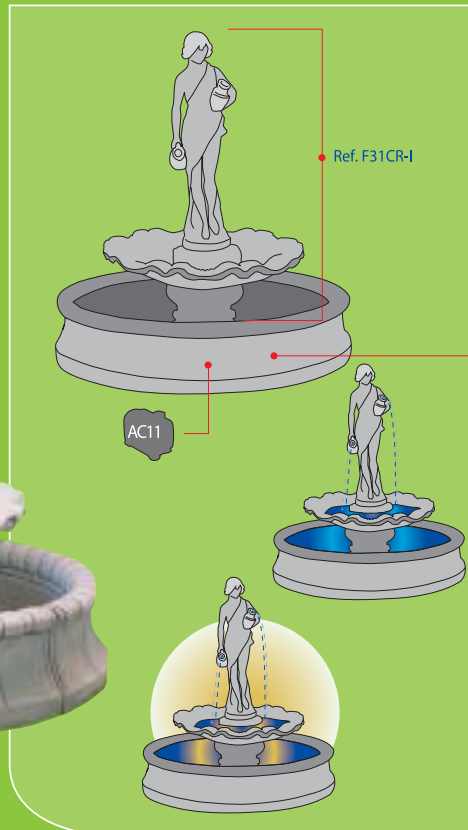

Ref. AC1

Kg 408
H 35 cm
Ø 182 cm

Ref. F31 Extra (F31+AC1+Kit agua D)

Kg 705
H 182 cm
Ø 182 cm

Ref. F31 SPE (F31+AC1+Kit agua D+Kit luz G)

Kg 712
H 182 cm
Ø 182 cm

# FUENTES CENTRALES FONTAINES CENTALES CENTRAL FOUNTAINS

(Fuente+AC10) Ref. F11CR

Kg 124  
H 156cm  
Ø 78cm

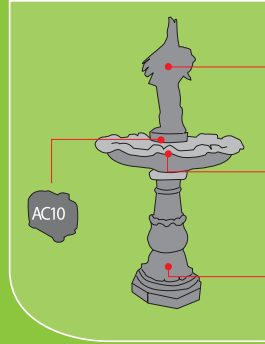

Kg 15  
H 64 cm  
Ø 21 cm

Ref. F14G

Kg 43  
H 14 cm  
Ø 78 cm

Ref. F11B

Kg 66  
H 78 cm  
Ø 43 cm

Ref. F11A

(Fuente+AC9) Ref. F18CR

Kg 78  
H 116 cm  
Ø 58 cm

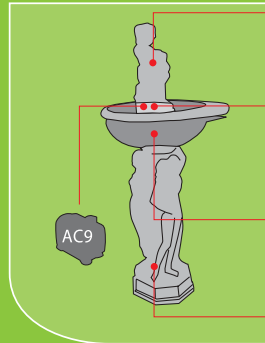

Kg 9  
H 46 cm  
Ø 16 cm

Ref. F23F

Kg 6  
H 15 cm  
Ø 20 cm

Ref. F17C

Kg 18  
H 19 cm  
Ø 45 cm

Ref. F17B

Kg 38  
H 70 cm  
Ø 28 cm

Ref. F17A

(Fuente+AC9) Ref. F17CR

Kg 71  
H 135 cm  
Ø 45 cm

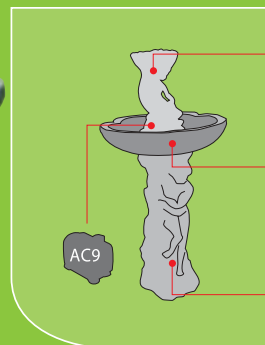

Kg 12  
H 41 cm  
Ø 22 cm

Ref. F18C

Kg 28  
H 18 cm  
Ø 58 cm

Ref. F18B

Kg 38  
L 31 cm  
A 27 cm  
H 69 cm

Ref. F18A

# ANIMALES ANIMAUX ANIMALS

Ref. AN13

Kg 31  
L 48 cm  
A 25 cm  
H 79 cm



Ref. AN20

Kg 16  
H 39 cm  
Ø 20 cm



Ref. AN18

Kg 15  
L 34 cm  
A 30 cm  
H 25 cm



Ref. AN15P

Kg 40  
L 54 cm  
A 27 cm  
H 82 cm



Ref. AN17G

Kg 193  
L 100 cm  
A 36 cm  
H 131 cm

Ref. AN19

Kg 18  
L 41 cm  
A 29 cm  
H 23 cm



Ref. AN21

Kg 13  
H 28 cm  
Ø 32 cm



Ref. AN23

Kg 3  
H 24 cm  
Ø 11 cm



Ref. AN22

Kg 5  
H 27 cm  
Ø 14 cm



Ref. AN30

Kg 28  
L 50 cm  
A 33 cm  
H 51 cm



# ANIMALES ANIMAUX ANIMALS

Ref. AN29CI

Kg 4  
L 23 cm  
A 15 cm  
H 21 cm



Ref. AN29L

Kg 5  
L 22 cm  
A 13 cm  
H 32 cm

Ref. AN29FT

Kg 5  
L 30 cm  
A 13 cm  
H 25 cm



Ref. AN29P

Kg 5  
L 26 cm  
A 15 cm  
H 32 cm

Ref. AN29A

Kg 4  
L 22 cm  
A 12 cm  
H 25 cm



Ref. AN29C

Kg 3  
L 22 cm  
A 12 cm  
H 19 cm

Ref. AN29Z

Kg 5  
L 25 cm  
A 15 cm  
H 27 cm



Ref. AN29G

Kg 8  
H 32 cm  
Ø 19 cm

Ref. D1

Kg 13  
L 25 cm  
A 20 cm  
H 57 cm



Ref. AN29PL

Kg 4  
L 33 cm  
A 11 cm  
H 25 cm

Ref. D2

Kg 27  
L 40 cm  
A 22 cm  
H 54 cm



Ref. D3

Kg 5  
H 35 cm  
Ø 13 cm

# ANIMALES ANIMAUX ANIMALS

Ref. AN31

Kg 5  
L 28 cm  
A 19 cm  
H 24 cm



Ref. AN32

Kg 3  
L 22 cm  
A 13 cm  
H 16 cm



Ref. AN34

Kg 5  
L 23 cm  
A 15 cm  
H 25 cm

Ref. AN28A

Kg 3  
L 15 cm  
A 14 cm  
H 25 cm



Ref. AN28D

Kg 3  
L 20 cm  
A 13 cm  
H 21 cm

Ref. AN28B

Kg 4  
L 17 cm  
A 14 cm  
H 24 cm



Ref. AN28E

Kg 4  
L 30 cm  
A 26 cm  
H 28 cm

Ref. AN28C

Kg 3  
L 23 cm  
A 13 cm  
H 24 cm



Ref. AN35

Kg 27  
H 63 cm  
Ø 24 cm

# ANIMALES

## ANIMAUX

### ANIMALS

Ref. AN3G-D

Kg 34  
 L 39 cm  
 A 23 cm  
 H 54 cm

Ref. AN3G-I



Ref. AN3P-D

Kg 14  
 L 28 cm  
 A 16 cm  
 H 41 cm

Ref. AN3P-I

Ref. AN7

Kg 17  
 L 30 cm  
 A 18 cm  
 H 36 cm



Ref. AN8

Kg 15  
 L 40 cm  
 A 25 cm  
 H 34 cm

Ref. AN42

Kg 8  
 L 21 cm  
 A 35 cm  
 H 20 cm



Ref. AN6

(Burro+Alforjas+HAN6)

Kg 45  
 L 60 cm  
 A 50 cm  
 H 85 cm



Ref. HAN6



Ref. AN6A

Ref. AN9

Kg 9  
 L 31 cm  
 A 17 cm  
 H 50 cm



Ref. AN10

Kg 23  
 H 57 cm  
 Ø 24 cm

# ANIMALES ANIMAUX ANIMALS

Ref. AN40a

Kg 4,4
A 14 cm
H 20 cm



Ref. AN41a

Kg 8,2
L 35
A 21
H 18



Ref. AN40b

Kg 4,4
A 14 cm
H 21 cm



Ref. AN41b

Kg 8
L 35
A 21
H 17



Ref. AN40c

Kg 4,5
A 15 cm
H 20 cm



Ref. AN41c

Kg 8,3
L 35
A 21
H 20



Ref. AN40d

Kg 4,5
A 17 cm
H 18 cm



Ref. AN41d

Kg 8,1
L 30
A 21
H 23





# FIGURAS

## STATUES

## FIGURES

Ref. E1

Kg 33

H 77 cm

B 21x17 cm



Ref. E47

Kg 26

H 62 cm

Ø 25 cm



Ref. E9

Kg 115

H 120 cm

B 33x33 cm



Ref. E10

Kg 102

H 120 cm

B 33x33 cm



Ref. F15

Kg 94

H 90 cm

Ø 51 cm



Ref. F16

Kg 94

H 90 cm

Ø 51 cm



# FIGURAS STATUES FIGURES

Ref. E26

Kg 79  
H 114 cm  
Ø 34 cm



Ref. E25

Kg 78  
H 100 cm  
Ø 29 cm



Ref. E17P

Kg 18  
H 70 cm  
Ø 22 cm



Ref. E54

Kg 24  
H 86 cm  
B 23x14 cm



Ref. E18M

Kg 76  
H 110 cm  
Ø 28 cm

Ref. E19G

Kg 139  
H 138 cm  
Ø 42 cm



Ref. E7

Kg 117  
H 131 cm  
B 40x35 cm



Ref. E20

Kg 35  
H 93 cm  
B 24x122 cm



# FIGURAS

## STATUES

## FIGURES

**Ref. E14**  
 Kg 63  
 H 120 cm  
 Ø 27 cm



**Ref. E11G**  
 Kg 145  
 H 150 cm  
 Ø 46 cm



**Ref. E12M**  
 Kg 86  
 H 120 cm  
 Ø 28 cm



**Ref. E52**  
 Kg 17  
 H 62 cm  
 Ø 18 cm

**Ref. E24**  
 Kg 273  
 H 164 cm  
 B 56x40 cm



**Ref. E27**  
 Kg 255  
 H 142 cm  
 B 48x48 cm



# FIGURAS STATUES FIGURES

Ref. E15
Kg 56
L 37 cm
A 27 cm
H 67 cm



Ref. E16
Kg 46
L 30 cm
A 26 cm
H 68 cm



(F17A+AC16)

Ref. E65
Kg 41
L 27 cm
H 102 cm



Ref. AC16
Bola Luz



Ref. 17A
Kg 38
H 70 cm
Ø 28 cm

Ref. E3
Kg 100
H 139 cm
Ø 31 cm



Ref. E55
Kg 101
H 119 cm
Ø 31 cm



AC16

# FIGURAS STATUES FIGURES

**Ref. E41**  
Kg 16  
H 47 cm  
B 17x17 cm



**Ref. E42**  
Kg 61  
H 67 cm  
B 40x40 cm

**Ref. E31**  
Kg 46  
H 87 cm  
B 35x27 cm



**Ref. E40**  
Kg 16  
H 50 cm  
B 34x25 cm

## PRODUCTO ESTRELLA

**Ref. E56**  
Kg 6  
L 19 cm  
A 19 cm  
H 38 cm



**Ref. E57**  
Kg 6  
L 19 cm  
A 19 cm  
H 34 cm

**Ref. E61**  
Kg 8,5  
L 14 cm  
H 51 cm



**Ref. E62**  
Kg 9,57  
L 14 cm  
H 51 cm

**Ref. E64**  
Kg 9,05  
L 14 cm  
H 50 cm



**Ref. E63**  
Kg 9,13  
L 14 cm  
H 50 cm

# FIGURAS STATUES FIGURES

Ref. E76

**Kg** 21  
**L** 38 cm  
**A** 22 cm  
**H** 52 cm



Ref. E77

**Kg** 24  
**L** 32 cm  
**A** 27 cm  
**H** 54 cm



Ref. E79

**Kg** 17  
**L** 26 cm  
**A** 26 cm  
**H** 26,5 cm



Ref. E78

**Kg** 111  
**L** 58 cm  
**A** 41 cm  
**H** 86 cm



Ref. E58

**Kg** 241  
**L** 150 cm  
**A** 90 cm  
**H** 43 cm



\*Embalaje individual de madera incluido en el precio.



# FIGURAS

## STATUES

## FIGURES

Ref. 59

**Kg** 732  
**L** 132 cm  
**A** 50 cm  
**H** 149 cm

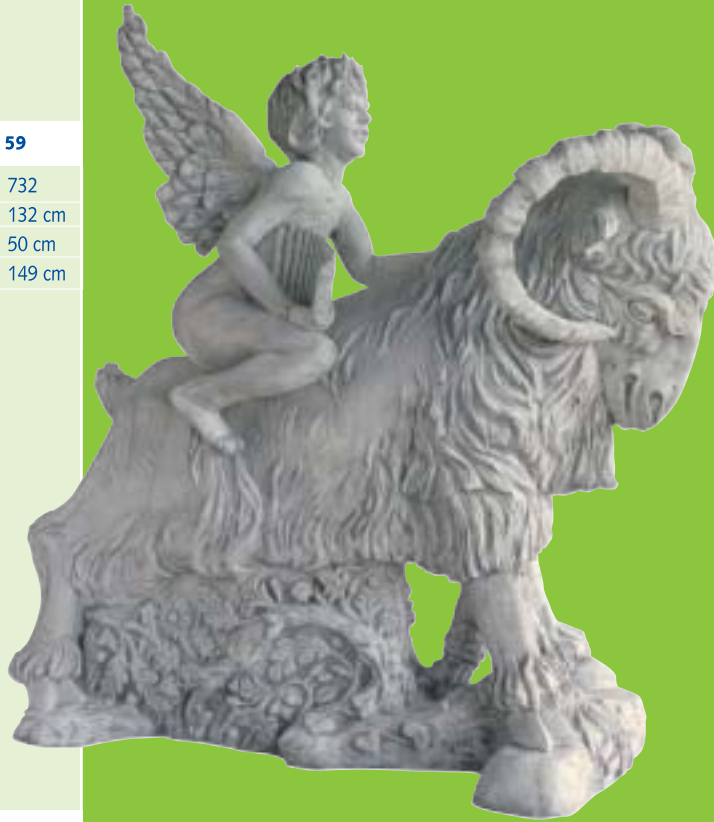

Ref. 60

**Kg** 732  
**L** 132 cm  
**A** 50 cm  
**H** 148 cm



Ref. E66

**Kg** 70  
**L** 45 cm  
**H** 107 cm



Ref. E67

**Kg** 70  
**L** 39 cm  
**H** 106 cm



Ref. E68D

**Kg** 5,5/u.  
**L** 23 cm  
**H** 45 cm



Ref. E68IZQ

**Kg** 5,5/u.  
**L** 23 cm  
**H** 45 cm



Ref. E69

**Kg** 2  
**L** 45 cm  
**H** 28 cm



Ref. E70

**Kg** 662  
**L** 132 cm  
**A** 45 cm  
**H** 120 cm



Ref. E71

**Kg** 0,5  
**L** 42 cm



Ref. E72D

**Kg** 8  
**L** 28 cm  
**H** 43 cm



Ref. E72IZQ

**Kg** 8  
**L** 28 cm  
**H** 43 cm

# MOLINOS MOULINS WINDMILLS

(Molino+AC17)	Ref. ML3
	Kg 8
	H 33 cm
	Ø 19 cm



(Molino+AC5)	Ref. ML1
	Kg 28
	H 68 cm
	Ø 30 cm

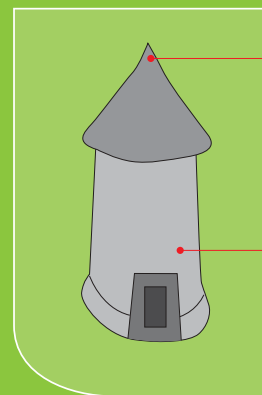

Ref. ML1B
Kg 6
H 24 cm
Ø 30 cm

Ref. ML1A
Kg 22
H 44 cm
Ø 28 cm

(Molino+AC6)	Ref. ML2
	Kg 117
	H 113 m
	Ø 49 cm

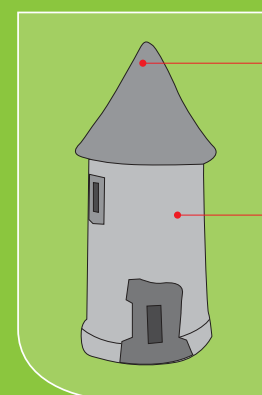
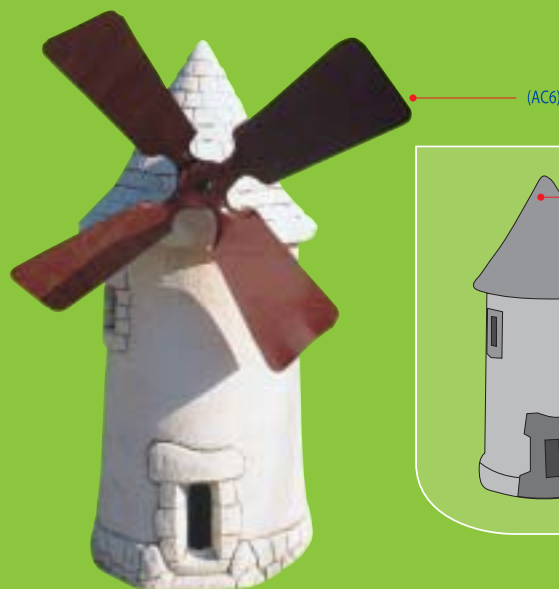

Ref. ML2B
Kg 32
H 41 cm
Ø 48 cm

Ref. ML2A
Kg 85
H 72 cm
Ø 49 cm

# PIZARRA ARDOISE SLATE

Ref. J28

Kg 79  
L 47 cm  
A 47 cm  
H 37 cm



Ref. J29

Kg 68  
H 30 cm  
Ø 60 cm



Ref. J30

Kg 133  
L 87 cm  
A 47 cm  
H 37 cm



Ref. F52

Kg 92  
L 49 cm  
A 53 cm  
H 90 cm

▲ (Fuente+AC4)  
▼

Ref. F52CR

AC10

# COLUMNAS COLONNES COLUMNS

(4AC1A)	Ref. AC1
	Kg 408
	H 35 cm
	Ø 182 cm

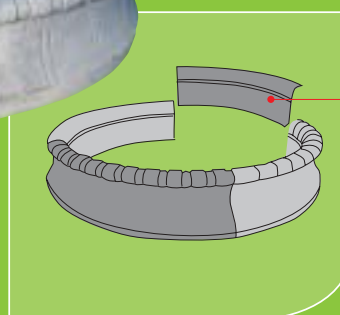

Ref. AC1A
Kg 102
H 35 cm
B 30 cm

Ref. B12
Kg 136
H 59 cm
Ø 48 cm



Ref. B13
Kg 40
H 48 cm
Ø 32 cm



# VARIOS DIVERS OTHERS

Ref. R10

**Kg** 10  
**Ø** 43 cm  
**G** 7,5 cm



Ref. R11

**Kg** 10  
**Ø** 43 cm  
**G** 7 cm

Ref. R12

**Kg** 13  
**Ø** 46 cm  
**G** 9 cm



Ref. E75

**Kg** 10  
**L** 48 cm  
**A** 50 cm  
**G** 5,5 cm

Ref. E73

**Kg** 13  
**L** 45 cm  
**A** 36 cm  
**G** 6,5 cm



Ref. E74

**Kg** 10,5  
**L** 40 cm  
**A** 38 cm  
**G** 6 cm

Ref. CC1

**Kg** 37,5  
**L** 65 cm  
**A** 21 cm  
**H** 41 cm



Ref. CC2

**Kg** 28  
**L** 64 cm  
**A** 32 cm  
**H** 33 cm

Ref. CC3

**Kg** 25  
**L** 50 cm  
**A** 28 cm  
**H** 28 cm



# OTROS AUTRES OTHERS

Ref. B5
Kg 39
H 48 cm
Ø 29 cm



Ref. B3G
Kg 37
L 62 cm
A 33 cm
H 36 cm



Ref. B6
Kg 189
H 43 cm
Ø 20 cm



Ref. B2M
Kg 13
L 40 cm
A 23 cm
H 24 cm



Ref. M1
Kg 19
H 21 cm
Ø 30 cm



Ref. B1P
Kg 10
L 34 cm
A 21 cm
H 18 cm



Ref. M6
Kg 50
H 28 cm
Ø 51 cm



Ref. M7
Kg 100
H 39 cm
Ø 61 cm



Ref. M5
Kg 33
H 24 cm
Ø 42 cm







IMPORTACIÓN DIRECTA-CHINA  
 IMPORTATION DIRECTE DE CHINE

# DECO CHINA



Ref. HJ-N-031

**Kg** 16  
**L** 48 cm  
**H** 83 cm



Ref. HJ-N-032

**Kg** 16  
**L** 51 cm  
**H** 75 cm



Ref. HJ-P-044

**Kg** 16  
**L** 45 cm  
**H** 37 cm



Ref. HJ-P-057

**Kg** 16  
**L** 46 cm  
**H** 36 cm



# MOBILIARIO ALUMINIO ABS MOBILIER ALUMINIUM ABS ALUMINIUM ABS FURNITURE



IMPORTACIÓN DIRECTA-CHINA  
IMPORTATION DIRECTE DE CHINE

Ref. HJ-073/1

**Kg** 57  
**L** 225 cm  
**A** 155 cm  
**H** 73 cm



Ref. HJ-078/1

**Kg** 30  
**L** 184 cm  
**A** 108 cm  
**H** 72 cm



Ref. HJ-070/1

**Kg** 29  
**L** 184 cm  
**A** 108 cm  
**H** 73 cm



Ref. HJ-070/01

**Kg** 29  
**L** 154 cm  
**A** 97 cm  
**H** 73 cm



Ref. HJH-015T

**Kg** 27  
**Ø** 107 cm  
**H** 73 cm



IMPORTACIÓN DIRECTA-CHINA  
IMPORTATION DIRECTE DE CHINE

# MOBILIARIO ALUMINIO ABS MOBILIER ALUMINIUM ABS ALUMINIUM ABS FURNITURE

Ref. HJ-069/1

**Kg** 39  
**L** 153 cm  
**A** 153 cm  
**H** 73 cm



Ref. HJ-C-028

**Kg** 5  
**L** 56 cm  
**H** 107 cm



Ref. HJ-D-002

**Kg** 39  
**L** 153 cm  
**H** 73 cm



Ref.  
HJ-D-002/A

**Kg** 9  
**L** 200 cm  
**A** 68 cm  
**H** 101 cm



Ref. HJ-C-027

**Kg** 3,5  
**L** 56 cm  
**H** 93 cm



# MOBILIARIO ALUMINIO ABS MOBILIER ALUMINIUM ABS ALUMINIUM ABS FURNITURE



IMPORTACIÓN DIRECTA-CHINA  
IMPORTATION DIRECTE DE CHINE

Ref. HJH-1001

**Kg** 10  
**L** 63,5 cm  
**A** 58 cm  
**H** 82 cm



Ref. HJC-011

**Kg** 4,5  
**L** 61,5 cm  
**A** 73 cm  
**H** 99,5 cm

Ref. HJG-076

**Kg** 4,2  
**L** 58,5 cm  
**A** 70 cm  
**H** 97 cm



Ref. HJ-G-002

**Kg** 4,2  
**L** 58 cm  
**H** 92 cm

Ref. HJ-030/1A

**Kg** 18  
**H** 73 cm  
**Ø** 102 cm

Ref. HJ-030/1B

**Kg** 19  
**H** 73 cm  
**Ø** 107 cm

Ref. HJ-030/1C

**Kg** 21,5  
**H** 73 cm  
**Ø** 122 cm



Ref. HJ-G-80

**Kg** 4  
**L** 55 cm  
**A** 70 cm



IMPORTACIÓN DIRECTA-CHINA  
IMPORTATION DIRECTE DE CHINE

# MOBILIARIO

## MOBILIER

### FURNITURE

Ref. JJ-T-006

**Kg** 7,5  
**H** 54 cm  
**Ø** 61 cm



Ref. JJ-C-016

**Kg** 7,2  
**L** 48 cm  
**A** 61 cm  
**H** 78 cm

Ref. JJ-T-003

**Kg** 7,2  
**H** 72 cm  
**Ø** 66 cm





# HIERRO FER IRON



IMPORTACIÓN DIRECTA-CHINA  
IMPORTATION DIRECTE DE CHINE

"RENAISSANCE"



Ref. F2273

Kg	55
L	48 cm
P	43 cm
H	81 cm

"FLORIA"



Ref. F2276

Kg	62
L	52 cm
P	37 cm
H	96 cm

\*Grifo incluido en el precio.

\*Embalaje individual de madera o cartón incluido en el precio.



Ref. YCR804

Kg	56,50
L	44 cm
H	207 cm
A	120 cm





IMPORTACIÓN DIRECTA-CHINA  
IMPORTATION DIRECTE DE CHINE

# HIERRO FER IRON

"ART DECO"



Ref. F2285

Kg 70  
L 68 cm  
P 38 cm  
H 108 cm

"ANGELOT"



Ref. F9968

Kg 25  
L 36 cm  
P 31 cm  
H 77,5 cm

"ABONDANCE"



Ref. F2286

Kg 35  
L 60 cm  
P 31 cm  
H 85 cm

"AUX ROSES"



Ref. F2282

Kg 26  
L 36 cm  
P 32 cm  
H 77 cm

\*Grifo incluido en el precio.

\*Embalaje individual de madera o cartón incluido en el precio.

# PIEDRA NATURAL PIERRE NATURAL NATURAL STONE



IMPORTACIÓN DIRECTA-CHINA  
IMPORTATION DIRECTE DE CHINE

Ref. 4536GY-030S

**Kg** 27  
**L** 30 cm  
**A** 30 cm  
**H** 30 cm



Ref. 4536GY-040S

**Kg** 48  
**L** 40 cm  
**A** 40 cm  
**H** 40 cm



Ref. 4545GY-065

**Kg** 42,50  
**L** 35 cm  
**A** 35 cm  
**H** 65 cm



Ref. 4501GY-049R

**Kg** 26,35  
**L** 30 cm  
**A** 30 cm  
**H** 49 cm

Ref. 4544GY-080R

**Kg** 47,60  
**L** 80 cm  
**A** 30 cm  
**H** 30 cm



IMPORTACIÓN DIRECTA-CHINA  
IMPORTATION DIRECTE DE CHINE

# PIEDRA NATURAL PIERRE NATURAL NATURAL STONE

Ref. 7121GY-120P

**Kg** 157,25  
**L** 122,5 cm  
**A** 30 cm  
**H** 45 cm



Ref. 7133GY-140

**Kg** 292  
**L** 152 cm  
**A** 40 cm  
**H** 72 cm

# PIEDRA NATURAL PIERRE NATURAL NATURAL STONE



IMPORTACIÓN DIRECTA-CHINA  
IMPORTATION DIRECTE DE CHINE

Ref. 3915GY-095

**Kg** 113,9  
**L** 45 cm  
**A** 45 cm  
**H** 95 cm



Ref. 3118PK-090

**Kg** 85  
**H** 87 cm  
**Ø** 41 cm



Ref. 3115GY-070

**Kg** 52  
**L** 40 cm  
**A** 30 cm  
**H** 70 cm



Ref. 3257GY-040

**Kg** 21  
**H** 41,5 cm  
**Ø** 30 cm





IMPORTACIÓN DIRECTA-CHINA  
IMPORTATION DIRECTE DE CHINE

# PIEDRA NATURAL PIERRE NATURAL NATURAL STONE

Ref. 4905PK-60

**Kg** 300  
**L** 40 cm  
**A** 40 cm  
**H** 58,5 cm



Ref. 1406GY-120

**Kg** 105  
**L** 31,5 cm  
**A** 23 cm  
**H** 123 cm



Ref. 1603PK-100

**Kg** 116  
**L** 36 cm  
**A** 34,50 cm  
**H** 102 cm



# INDICE SOMMAIRE INDEX

4	<b>PRODUCTOS / PRODUITS / PRODUCTS</b>
5	<b>PEDIDOS / COMMANDES / ORDERS</b>
6	<b>NOTAS / NOTES / NOTES</b>
7	<b>BOMBAS / POMPES / PUMPS</b>
8	<b>KIT DE AGUA / KIT D'EAU / WATER KIT</b>
9	<b>KIT DE LUZ / KIT D'ECLAIRAGE / ELECTRICITY KIT</b>
10	<b>ACCESORIOS / ACCESSOIRES / ACCESSORIES</b>
12	<b>ABREVADEROS / AUGES / TROUGHS</b>
16	<b>POZOS / PUITS / WELLS</b>
17	<b>COPAS / COUPES / GOLBLETS</b>
19	<b>JARDINERAS / JARDINIERES / WINDOW BOXES</b>
23	<b>SALONES / SALONS / LOUNGES</b>
24	<b>PICAS Y BARBACOA / PIQUES ET BARBACOA / GOADS AND BARBECUE</b>
25	<b>BANCOS / BANCS / BENCHES</b>
26	<b>RELOJES / CADRAN SOLAIRE / CLOCKS</b>
28	<b>FUENTES / FONTAINES / FOUNTAINS</b>
36	<b>FUENTES CENTRALES / FONTAINES CENTRALES / CENTRAL FOUNTAINS</b>
39	<b>ANIMALES / ANIMAUX / ANIMAL</b>
44	<b>FIGURAS / STATUES / FIGURES</b>
51	<b>MOLINOS / MOULINS / WINDMILLS</b>
52	<b>PIZARRA / ARDOISE / SLATE</b>
53	<b>COLUMNAS / COLONNES / COLUMNS</b>
54	<b>VARIOS / DIVERS / OTHERS</b>
56	<b>DECO CHINA</b>
57	<b>MOBILIARIO ALUMINIO ABS / MOBILIER ALUMINIUM ABS / ALUMINIUM ABS FURNITURE</b>
60	<b>MOBILIARIO / MOBILIER / FURNITURE</b>
61	<b>HIERRO / FER / IRON</b>
63	<b>PIEDRA NATURAL / PIERRE NATURAL / NATURAL STONE</b>



**DECOJARDÍ**  
EMPORDÀ





**DECOJARDÍ**  
EMPORDÀ

Ctra. d'Agullana a Terrades, s/n  
17707 **AGULLANA** (Girona) • SPAIN  
Tel. (0034) 972 535 245  
Fax. (0034) 972 535 655

[info@decojardi.com](mailto:info@decojardi.com)  
[www.decojardi.com](http://www.decojardi.com)

